



# LD2979 SERIES

## VERY LOW DROP VOLTAGE REGULATORS WITH INHIBIT

- VERY LOW DROPOUT VOLTAGE (0.2V TYP. AT 50mA LOAD)
- VERY LOW QUIESCENT CURRENT (TYP. 500 $\mu$ A AT 50mA LOAD)
- OUTPUT CURRENT UP TO 50 mA
- LOGIC-CONTROLLED ELECTRONIC SHUTDOWN
- OUTPUT VOLTAGES OF 2.85; 3.0; 3.2; 3.3; 3.8; 5.0V
- INTERNAL CURRENT AND THERMAL LIMIT
- SUPPLY VOLTAGE REJECTION: 63dB (TYP)
- ONLY 1 $\mu$ F FOR STABILITY
- SELECTION AT 25 °C
- TEMPERATURE RANGE: -25 TO 125 °C
- PACKAGE AVAILABLE: SOT23-5L AND TO-92

### DESCRIPTION

The LD2979 series are very Low Drop regulators available in SOT23-5L and TO-92.

The very low drop-voltage and the very low quiescent current make them particularly suitable for low noise, low power applications and in battery powered systems.

Shutdown Logic Control function is available on five pin version (TTL compatible). This means

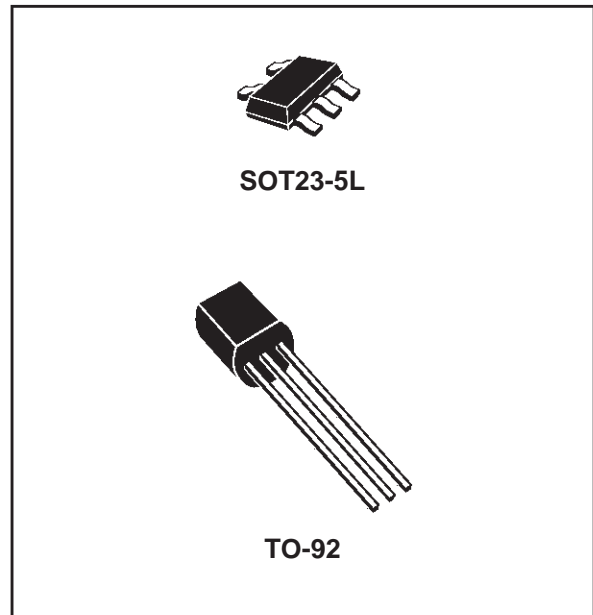

that when the device is used as local regulator, it is possible to put a part of the board in standby, decreasing the total power consumption.

### SCHEMATIC DIAGRAM

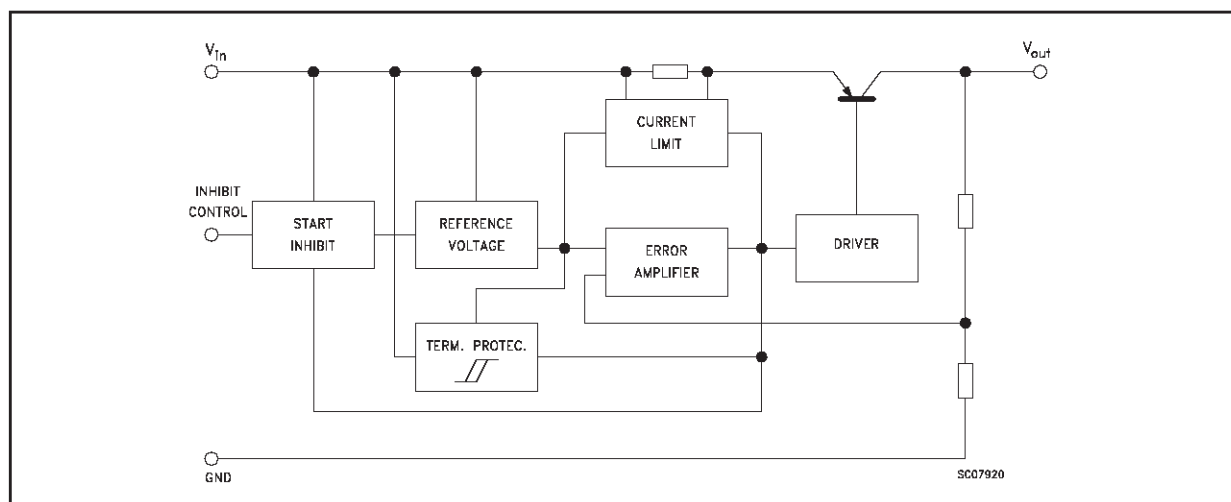

## LD2979

### ABSOLUTE MAXIMUM RATING

Symbol	Parameter	Value	Unit
$V_{IN}$	DC Input Voltage	16	V
$V_{INH}$	DC Inhibit Input Voltage	$V_{IN}$	V
$I_o$	Output Current	Internally limited	mA
$P_{tot}$	Power Dissipation	Internally limited	mW
$T_{stg}$	Storage Temperature Range	- 40 to 150	°C
$T_{op}$	Operating Junction Temperature Range	- 25 to 125	°C

### CONNECTION DIAGRAM (top view)



SYMBOL	NAME AND FUNCTION	PIN NUMBER	
		SOT23-5L	TO-92
$V_{IN}$	Input Voltage	1	3
GND	Ground	2	2
INHIBIT	Control Switch ON/OFF (*)	3	-
NC	Not to be connected	4	-
$V_{OUT}$	Output Voltage	5	1

(\*) Only for the version in SOT23-5L package: Inhibit pin is not internally pulled-up then it must not be left floating. Connect to a positive voltage higher than 2V to able the device.

### ORDERING NUMBERS

SOT23-5L (T&R)	TO-92	TO-92 (T&R)	TO-92 (Ammo Pack)	Output Voltage
LD2979M28TR	LD2979Z28	LD2979Z28TR	LD2979Z28AP	2.85 V
LD2979M30TR	LD2979Z30	LD2979Z30TR	LD2979Z30AP	3.0 V
LD2979M32TR	LD2979Z32	LD2979Z32TR	LD2979Z32AP	3.2 V
LD2979M33TR	LD2979Z33	LD2979Z33TR	LD2979Z33AP	3.3 V
LD2979M38TR	LD2979Z38	LD2979Z38TR	LD2979Z38AP	3.8 V
LD2979M50TR	LD2979Z50	LD2979Z50TR	LD2979Z50AP	5.0 V

**ELECTRICAL CHARACTERISTICS FOR LD2979** (refer to the test circuits,  $T_a = 25\text{ }^\circ\text{C}$ ,  
 $V_{IN} = V_{O(NOM)} + 1$ ,  $C_O = 1\text{ }\mu\text{F}$ ,  $I_O = 1\text{ mA}$ ,  $V_{inh} = 2V^{(*)}$ ) (unless otherwise specified)

Symbol	Parameter	Test Conditions	Min.	Typ.	Max.	Unit
$V_o$	Output Voltage	$V_{IN} = 3.85\text{ V}$	2.793	2.85	2.907	V
		$1 < I_o < 50\text{ mA}$ , $-25 < T_a < 125\text{ }^\circ\text{C}$	2.736		2.964	V
$V_o$	Output Voltage	$V_{IN} = 4\text{ V}$	2.940	3	3.060	V
		$1 < I_o < 50\text{ mA}$ , $-25 < T_a < 125\text{ }^\circ\text{C}$	2.880		3.120	V
$V_o$	Output Voltage	$V_{IN} = 4.2\text{ V}$	3.136	3.2	3.264	V
		$1 < I_o < 50\text{ mA}$ , $-25 < T_a < 125\text{ }^\circ\text{C}$	3.072		3.328	V
$V_o$	Output Voltage	$V_{IN} = 4.3\text{ V}$	3.234	3.3	3.366	V
		$1 < I_o < 50\text{ mA}$ , $-25 < T_a < 125\text{ }^\circ\text{C}$	3.168		3.432	V
$V_o$	Output Voltage	$V_{IN} = 4.8\text{ V}$	3.724	3.8	3.876	V
		$1 < I_o < 50\text{ mA}$ , $-25 < T_a < 125\text{ }^\circ\text{C}$	3.648		3.952	V
$V_o$	Output Voltage	$V_{IN} = 6\text{ V}$	4.9	5	5.1	V
		$1 < I_o < 50\text{ mA}$ , $-25 < T_a < 125\text{ }^\circ\text{C}$	4.8		5.2	V
$I_{out}$	Output Current Limit		100			mA
$\Delta V_o$	Line Regulation	$V_{O(NOM)} + 1 < V_{IN} < 16\text{ V}$ , $I_o = 1\text{ mA}$ $-25 < T_a < 125\text{ }^\circ\text{C}$			0.028 0.064	%/ $V_{in}$
$I_d$	Quiescent Current	ON MODE $I_o = 0\text{ mA}$		80	110	$\mu\text{A}$
		$I_o = 0\text{ mA}$ , $-25 < T_a < 125\text{ }^\circ\text{C}$			170	$\mu\text{A}$
$I_d$	Quiescent Current	$I_o = 50\text{ mA}$		500	700	$\mu\text{A}$
		$I_o = 50\text{ mA}$ , $-25 < T_a < 125\text{ }^\circ\text{C}$			1300	$\mu\text{A}$
$I_d$	Quiescent Current	OFF MODE (*) $V_{inh} < 0.18\text{ V}$		0		$\mu\text{A}$
		$V_{inh} < 0.18\text{ V}$ , $-25 < T_a < 125\text{ }^\circ\text{C}$			1	$\mu\text{A}$
SVR	Supply Voltage Rejection	$I_o = 50\text{ mA}$ , $f = 120\text{ Hz}$ , $C_{out} = 10\text{ }\mu\text{F}$		63		dB
$V_d$	Dropout Voltage	$I_o = 0\text{ mA}$		6	12	mV
		$I_o = 0\text{ mA}$ , $-25 < T_a < 125\text{ }^\circ\text{C}$			18	mV
		$I_o = 1\text{ mA}$		30	60	mV
		$I_o = 1\text{ mA}$ , $-25 < T_a < 125\text{ }^\circ\text{C}$			90	mV
		$I_o = 10\text{ mA}$		100	200	mV
		$I_o = 10\text{ mA}$ , $-25 < T_a < 125\text{ }^\circ\text{C}$			300	mV
$V_d$	Dropout Voltage	$I_o = 50\text{ mA}$		200	400	mV
		$I_o = 50\text{ mA}$ , $-25 < T_a < 125\text{ }^\circ\text{C}$			600	mV
$V_{il}$	Control Input Logic Low	$-25 < T_a < 125\text{ }^\circ\text{C}$ (*) Device Off			0.18	V
$V_{ih}$	Control Input Logic High	$-25 < T_a < 125\text{ }^\circ\text{C}$ (*) Device On	2			V
$I_i$	Control Input Current	$V_{inhibit} = 0\text{ V}$ (*)		0	-1	$\mu\text{A}$
		$V_{inhibit} = 5\text{ V}$ , $-25 < T_a < 125\text{ }^\circ\text{C}$ (*)		5	15	$\mu\text{A}$
eN	Output Noise Voltage (RMS)	$\text{BW} = 300\text{ Hz to } 50\text{ KHz}$ , $C_{out} = 10\text{ }\mu\text{F}$		160		$\mu\text{V}$

(\*) Note: Only for types in SOT23-5L

**TYPICAL PERFORMANCE CHARACTERISTICS** (unless otherwise specified  $T_a=25^\circ\text{C}$ )

Output Voltage vs Temperature

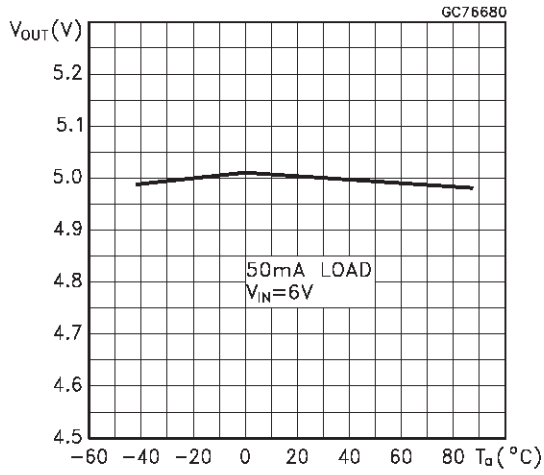

Output Voltage vs Input Voltage

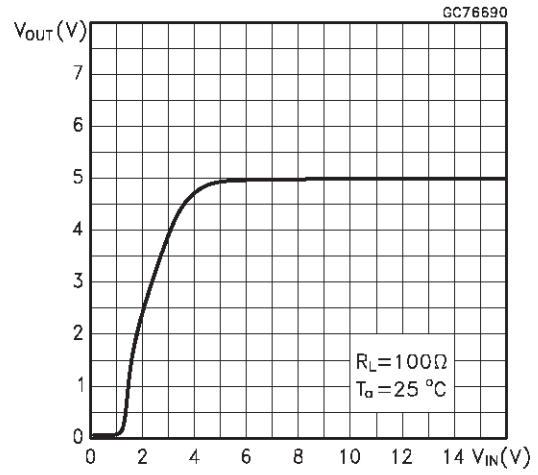

Output Voltage vs Input Voltage

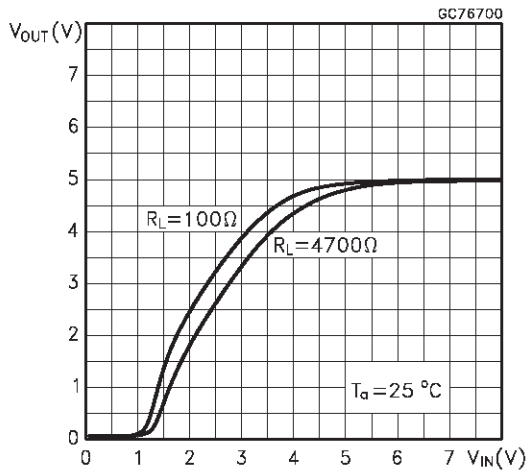

Dropout Voltage vs Output Current

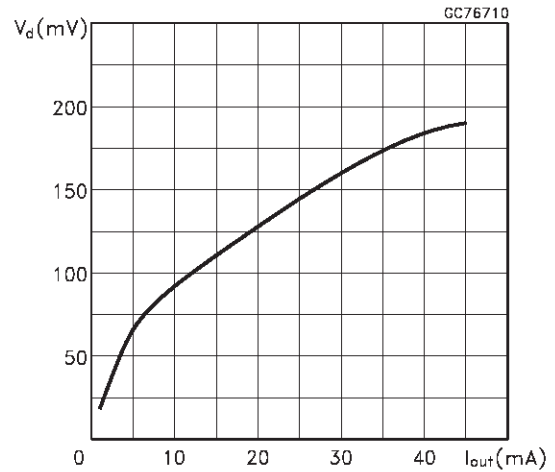

Dropout Voltage vs Temperature

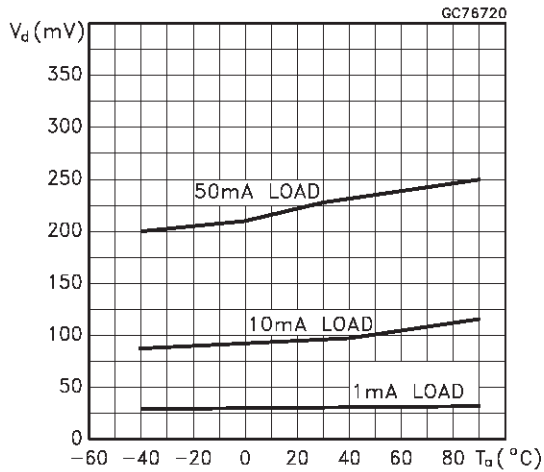

Quiescent Current vs Temperature

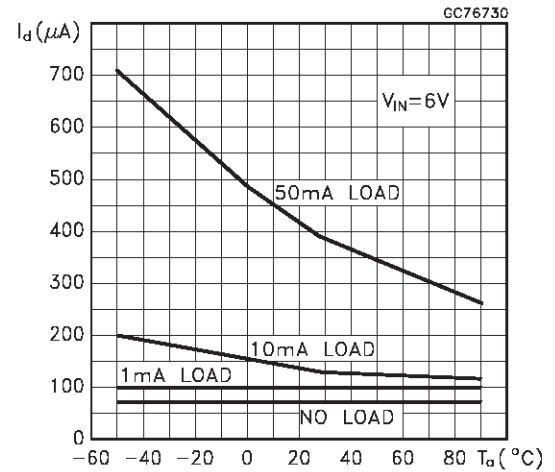

TYPICAL PERFORMANCE CHARACTERISTICS (continued)

Short Circuit Current vs Dropout Voltage

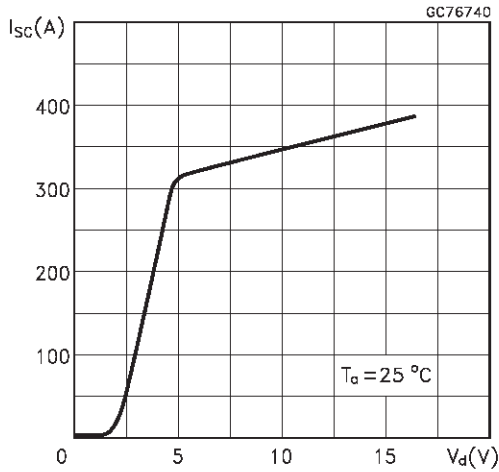

S.V.R. vs Frequency

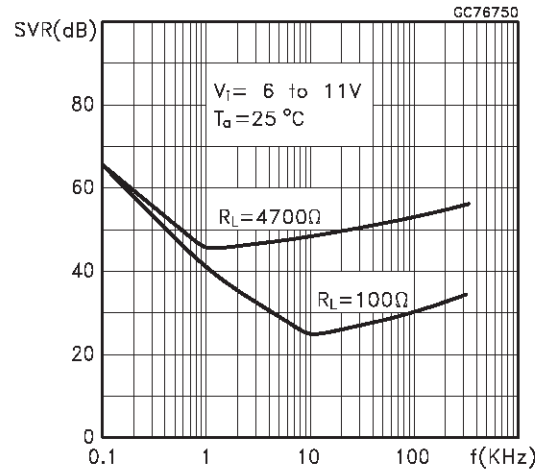

Inhibit Current vs Temperature

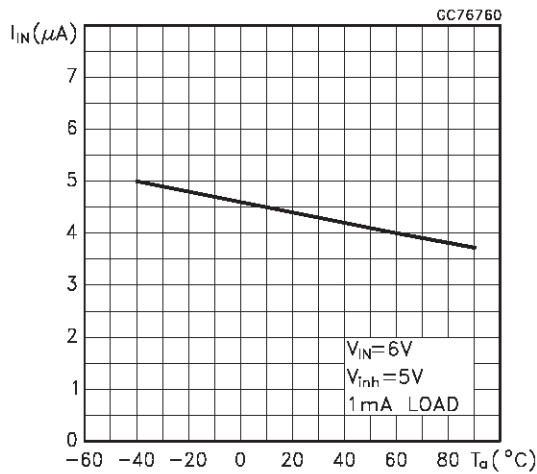

Inhibit Voltage vs Temperature

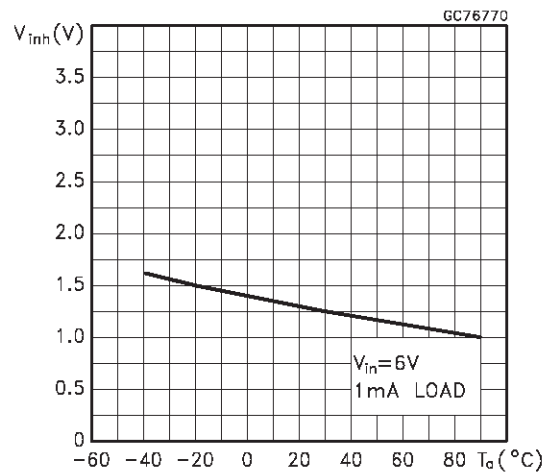

Load Transient Response

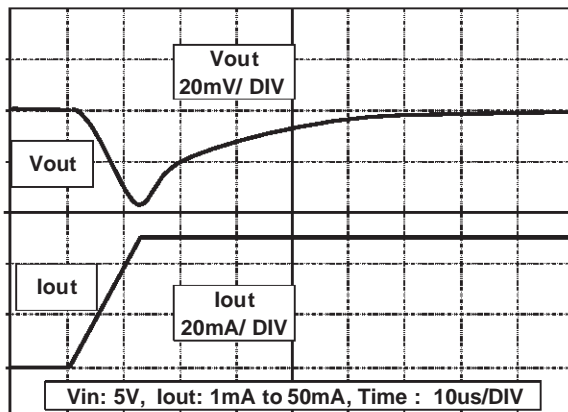

$C_o = 10\mu\text{F}$  (ESR=1 $\Omega$  at 1KHz)

Load Transient Response

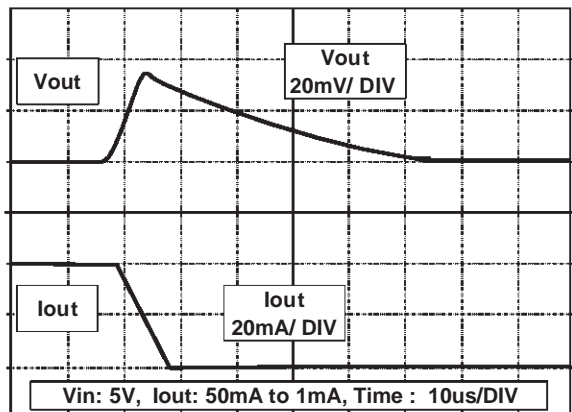

$C_o = 10\mu\text{F}$  (ESR=1 $\Omega$  at 1KHz)

TYPICAL PERFORMANCE CHARACTERISTICS (continued)

Line Transient Response

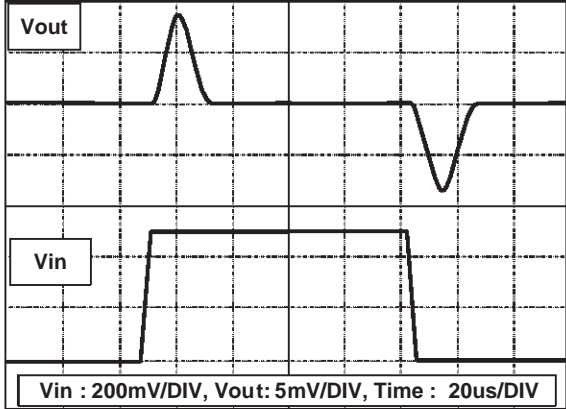

V<sub>CC</sub> = 4.75 to 5.25V, I<sub>OUT</sub> = 0.1A, C<sub>O</sub> = 10μF (ESR=1Ω at 1KHz)



**TO-92 MECHANICAL DATA**

DIM.	mm			inch		
	MIN.	TYP.	MAX.	MIN.	TYP.	MAX.
A	4.58		5.33	0.180		0.210
B	4.45		5.2	0.175		0.204
C	3.2		4.2	0.126		0.165
D	12.7			0.500		
E		1.27			0.050	
F	0.4		0.51	0.016		0.020
G	0.35			0.14		

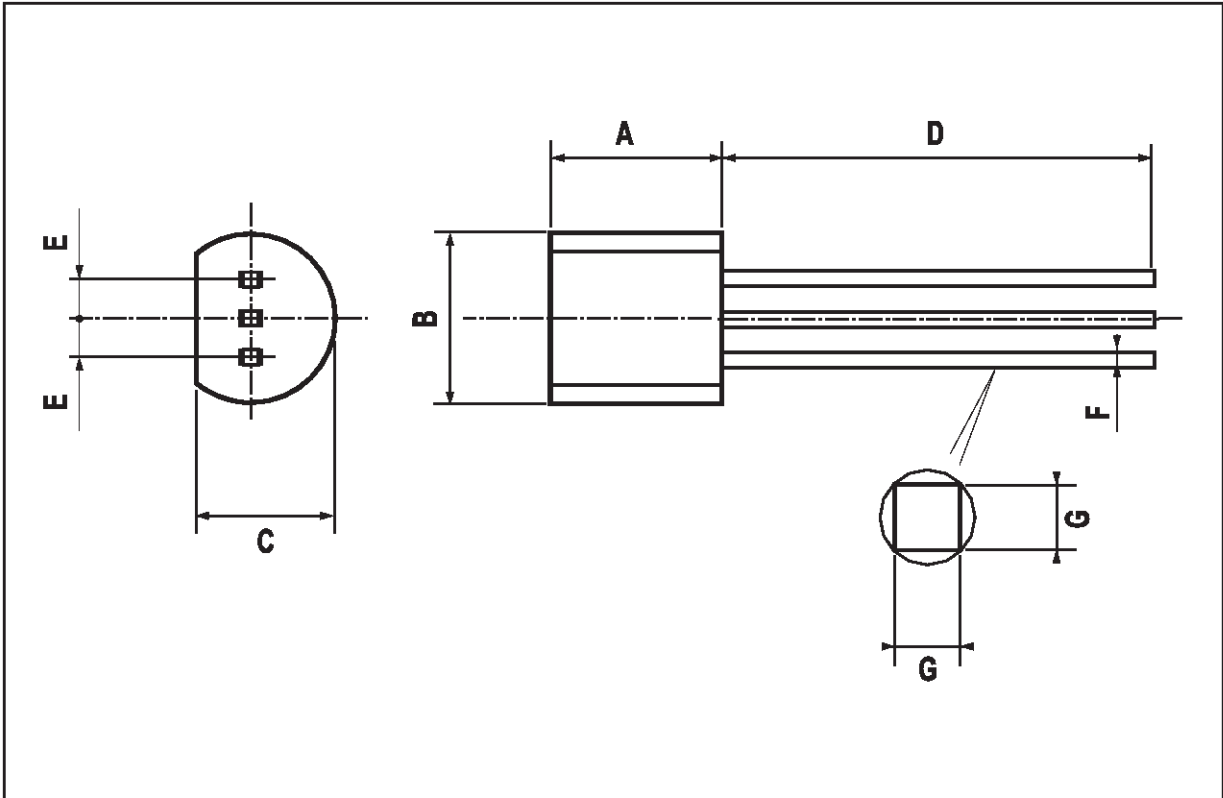



Information furnished is believed to be accurate and reliable. However, STMicroelectronics assumes no responsibility for the consequences of use of such information nor for any infringement of patents or other rights of third parties which may result from its use. No license is granted by implication or otherwise under any patent or patent rights of STMicroelectronics. Specification mentioned in this publication are subject to change without notice. This publication supersedes and replaces all information previously supplied. STMicroelectronics products are not authorized for use as critical components in life support devices or systems without express written approval of STMicroelectronics.

The ST logo is a registered trademark of STMicroelectronics

© 2000 STMicroelectronics – Printed in Italy – All Rights Reserved

STMicroelectronics GROUP OF COMPANIES

Australia - Brazil - China - Finland - France - Germany - Hong Kong - India - Italy - Japan - Malaysia - Malta - Morocco  
Singapore - Spain - Sweden - Switzerland - United Kingdom - U.S.A.

<http://www.st.com>